

GROUP 43 MANUAL GEARBOX

Description

GEARBOX

The gearbox, see Fig. 43-1, is a four-speed, synchronized gearbox with all gears except reverse synchronized. The synchronizing design can be seen from Fig. 43-2. Engaging and disengaging the synchronizing is shown in Figs. 43-3 and 43-4. Power from the gearbox to the differential carriers is transmitted by an auxiliary gearbox which is fixed to the rear end of the gearbox.

The gearbox design can be seen from Illustrations 43-A, B and C. The gearbox housing is in two sections one front and one rear, and is made of aluminium. The input and output shafts in the housing are journaled in ball bearings and the countershaft in roller bearings. The reverse shaft is not journaled and is driven directly in the housing. All gears are of the helical type and all except the gears for reverse shaft are in continuous mesh.

Gear-changing is by means of the gear lever, see Fig. 43-5, the movements of which are transmitted via a gear shift bar and link arms, see Fig. 43-6. The gear lever is also used for operating the auxiliary gearbox, and a special housing is mounted on the gearbox selector fork housing. The various gear positions and the path taken by the transmission in different gears can be seen from Figs. 43-7-43-11.

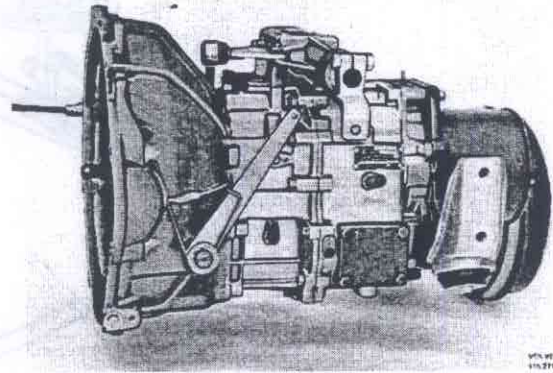

Fig. 43-1. Gearbox

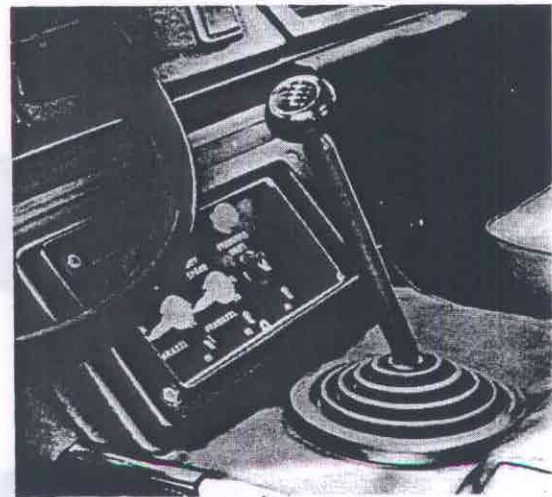
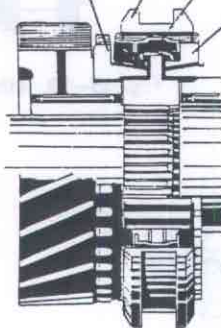

Fig. 43-5. Gear lever

Ring gear Engaging sleeve
Inhibitor
Synchronizing cone



VOLVO
115 264

Fig. 43-2. Synchronizing, neutral

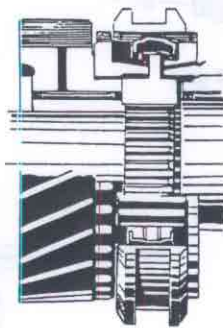

VOLVO
115 265

Fig. 43-3. Synchronizing

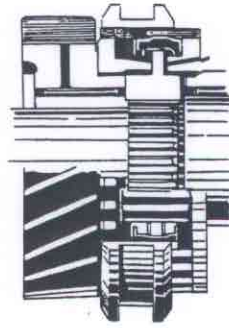

VOLVO
115 266

Fig. 43-4. Gear engaged

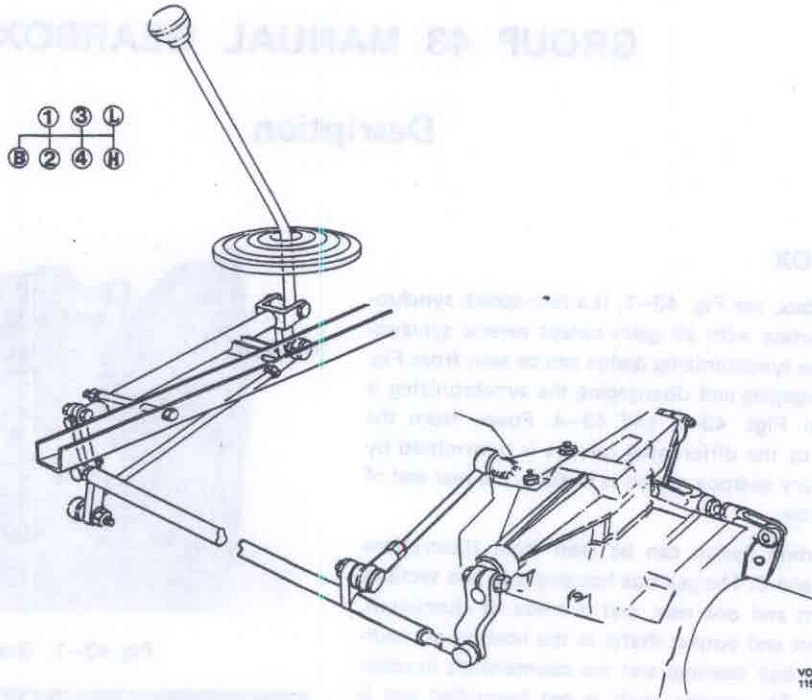

Fig. 43-6. Gear-change linkage

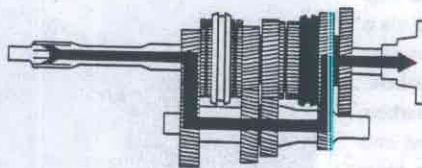

Fig. 43-7. 1st gear

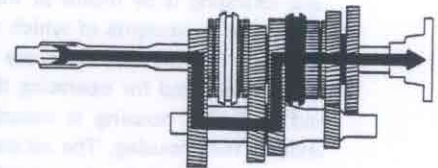

Fig. 43-8. 2nd gear

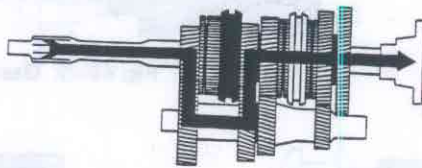

Fig. 43-9. 3rd gear

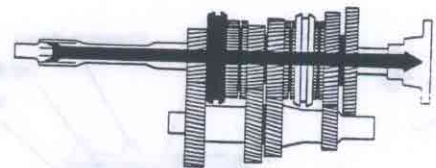

Fig. 43-10. 4th gear

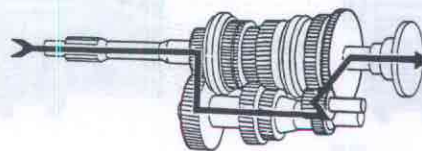

Fig. 43-11. Reverse

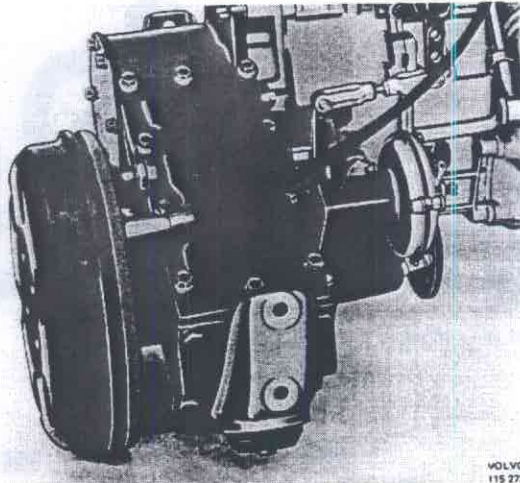

Fig. 43-12. Auxiliary gearbox

AUXILIARY GEARBOX

The auxiliary gearbox, Fig. 43-12, has a high gear and a low gear and is synchronized on both. The synchronization is of the same type and size as that of the main gearbox.

The high gear is primarily intended for road driving and the low gear for cross-country driving.

The auxiliary gearbox is mounted on the rear end of the standard gearbox and its function is to transfer the power from the standard gearbox to the front or rear differential carriers. The gear lever for the standard gearbox is used for gear-changing the auxiliary gearbox. An indicator is situated on the dashboard, see Fig. 43-13, which shows the gear engaged.

When any of the auxiliary gearbox's gears is engaged, rear wheel drive is also engaged. Front wheel drive is engaged separately by means of the control mechanism at the front of the auxiliary gearbox, see Fig. 43-16.

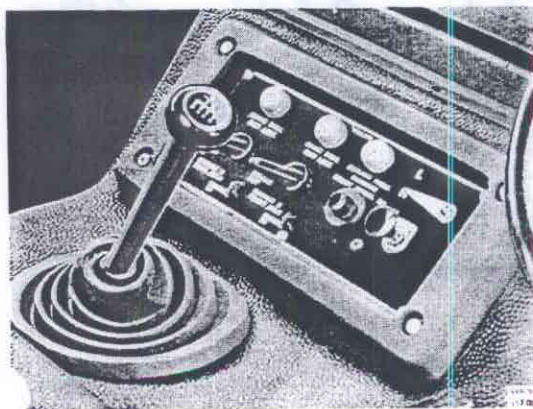

Fig. 43-13. Indicator

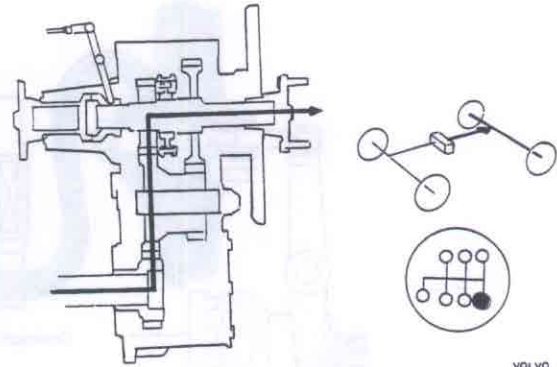

Fig. 43-14. High gear

VOLVO
115 289

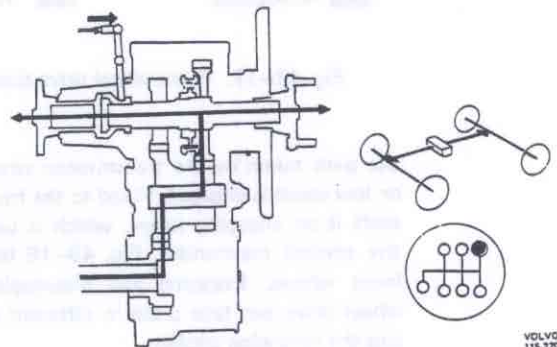

Fig. 43-15. Low gear

VOLVO
115 279

The auxiliary gearbox has a cluster gear, a counter-shaft and an output shaft. Power from the standard gearbox is transmitted via the cluster gear, which is linked to the auxiliary gearbox by means of a sleeve mounted on the output shaft for the standard gearbox. On the auxiliary gearbox output shaft there are two idler gears, one for the high speed and one for the low speed as well as a synchronizing unit. Fitted on the output shaft is a flange which is used for driving the rear wheels. Figs. 43-14 and 43-15 show

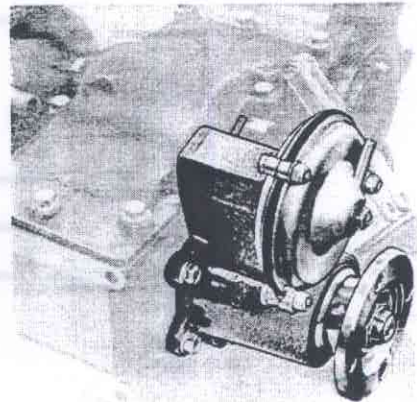

Fig. 43-16. Sleeve mounted.

VOLVO
115 279

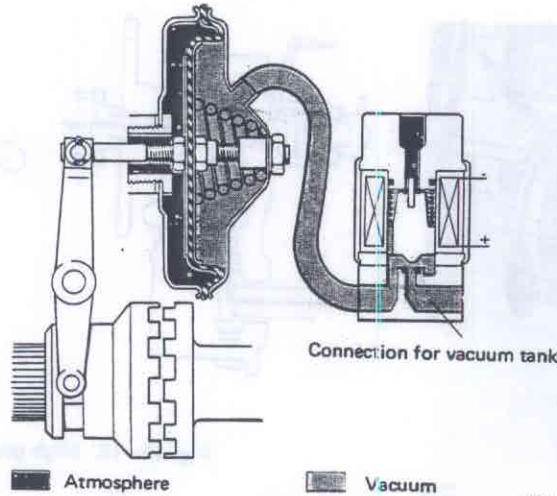

Fig. 43-17. Front wheel drive disengaged

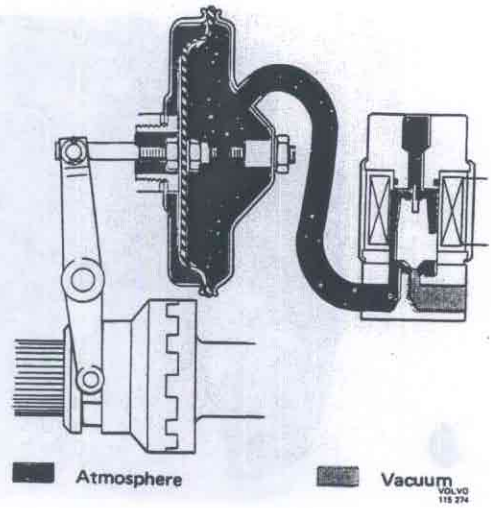

Fig. 43-18. Front wheel drive engaged

the path taken by the transmission when high speed or low speed is engaged. Fixed to the front end of the shaft is an engaging sleeve, which is used to engage the control mechanism, Fig. 43-16 for driving the front wheels. Engaging and disengaging the front wheel drive can take place in different ways and for this the following applies:

FRONT WHEEL DRIVE

Disengaged position

When the solenoid valve is in current its armature is pulled upwards, see Fig. 43-17. This opens the connection between the vacuum tank in the frame and the control cylinder on the control mechanism. As a result of the vacuum in the diaphragm, the pull

rod pulls from the flange sleeve in the control mechanism and disengages the front wheel drive.

Engaged position

When there is no current through the solenoid valve, its armature is pressed down by the spring, Fig. 43-18. This breaks the connection between the vacuum tank and the control cylinder and the cylinder is connected up instead with the outside air. Since there is then atmospheric pressure on both sides of the diaphragm, the thrust spring in the cylinder can press in the pull rod to engage the flange sleeve and thus also engage the front wheel drive.

Front-wheel drive is also engaged when there is no vacuum.

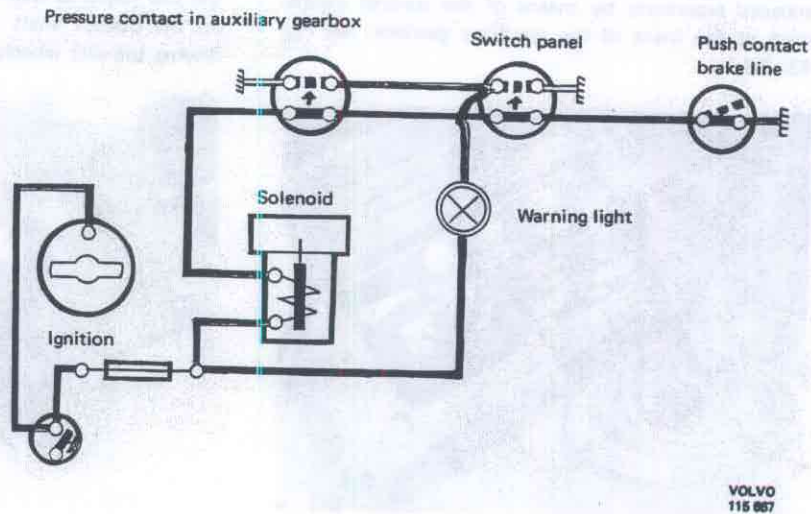

Fig. 43-19. Wiring diagram, front wheel drive

Operation

As the above shows, disengaging and engaging of the front wheel drive is governed by the fact whether the solenoid valve is in current or not. Fig. 43-19 shows the wiring diagram and the various possibilities for operating the front wheel drive.

- A. Ignition. With the ignition key in neutral, the current circuit is broken and front wheel drive is thus engaged. Turning the key disengages the front wheel drive providing that there is vacuum in the frame tanks and the contacts and switch are in the position shown by Fig. 43-19.
- B. Gear lever. Engaging low gear breaks the contacts 50-50 in the auxiliary gearbox. This cuts out the current through the solenoid valve and front wheel drive is engaged. At the same time contacts 15-15 close and the control light goes on.

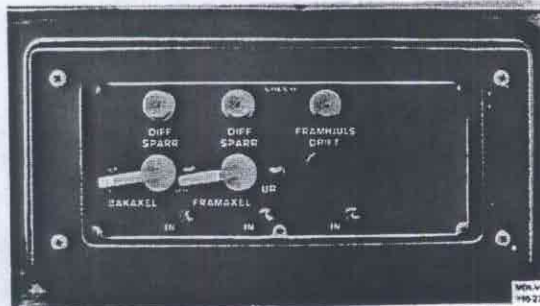

Fig. 43-20. Switch

- C. Panel switch see Fig. 43-20. Pushing in this switch breaks the contact 49-15. This cuts out the current through the solenoid valve and front wheel drive is engaged. At the same time switch 49a-R closes and the control light goes on.

Service procedures

WORK ON TRANSMISSION IN VEHICLE

Adjusting the gear-position indicator

1. Move the gear selector to neutral.
2. Slacken the nut securing the indicator arrow.
3. Turn the arrow so that it points to N. See Fig. 43-21 a.
4. Tighten up the nut.

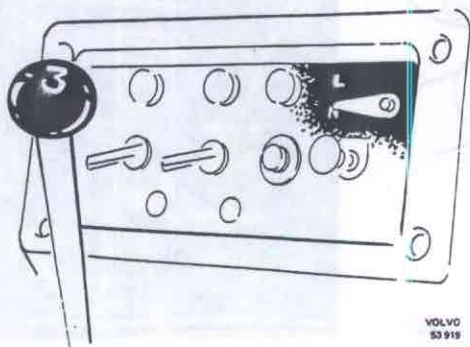

Fig. 43-21a. Indicator

Auxiliary gearbox

Removing the cover

1. Remove the casing over the engine.
2. Remove the bolts securing the floor plate and remove the plate.
3. Remove the stowage box and cover over the engine casing.

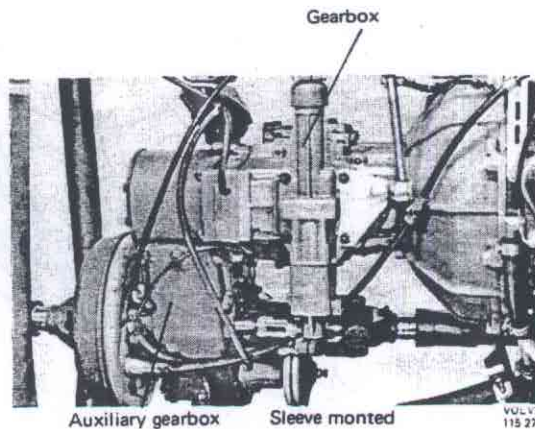

Fig. 43-21b. Gearbox in vehicle

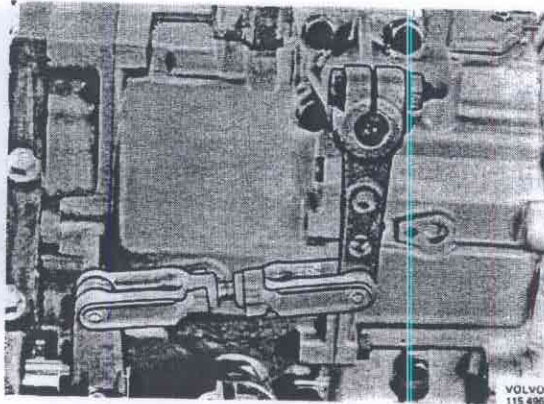

Fig. 43-22. Link

4. Remove the parking brake wire from the lever. Remove the clamp securing the wire to the engine.
5. Disconnect the cable to the sender on the cover. Remove the link arm from the lever on the auxiliary gearbox, see Fig. 43-22.
6. Remove the screws for the cover. Pull the wire out of the guide sleeve on the propeller shaft brake and lift up the cover.

Installing the cover

1. Clean the contact surface on the cover and the auxiliary gearbox. Coat the surface of the auxiliary gearbox with sealing agent.

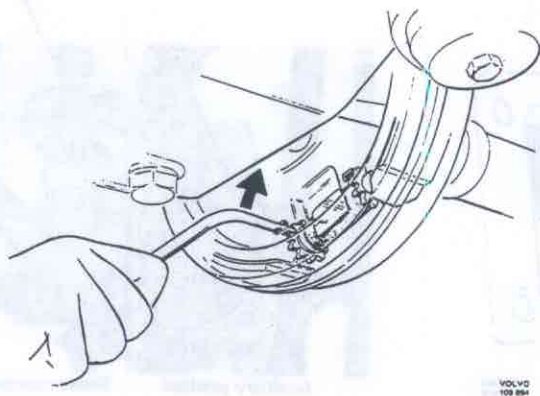

Fig. 43-23. Adjusting brake shoes

2. Hold the wire out of the way and fit the cover in position. Tighten up the screws.
3. Fit the link arm and connect up the cable to the sender.
4. Fix the wire to the lever. Clamp the wire to the engine with the clamp. Tighten the nut so that full braking is obtained at the 4th-5th ratchet with the propeller shaft brake properly adjusted. If necessary, adjust the parking brake according to points 6 and 7.
5. Place the floor plate in position and screw tight the bolts. Fit the engine casing.
6. Adjust out one of the brake shoes with a screwdriver (Fig. 43-23) until it is just possible to rotate the drum with the rear end jacked up. Slacken the adjuster screw until the drum rotates freely, but maximum five teeth. Adjust the other brake shoe in the same way.
7. Check the function of the control lever. If the parking brake does not give full braking at 4th-5th ratchet, in spite of the fact that the propeller shaft brake is properly adjusted, alter the length of the wire with the nut at the front end.

Replacing the control mechanism

Removing

1. Remove the casing from the engine. Remove the bolts securing the floor plate. Remove the plate. Drain the oil from the auxiliary gearbox.

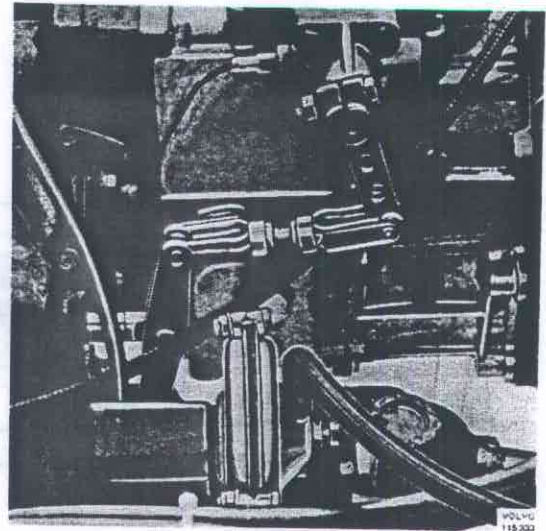

Fig. 43-24. Control mechanism



Fig. 43-25. Removing cover

2. Remove the bolts securing the propeller shaft and remove the shaft.
3. Disconnect the hose to the control cylinder, see Fig. 43-24. Remove the evacuation hose to the control mechanism housing.
4. Remove the bolts securing the control mechanism housing to the auxiliary gearbox.

Installing

1. Clean the contact surface on the auxiliary gearbox.

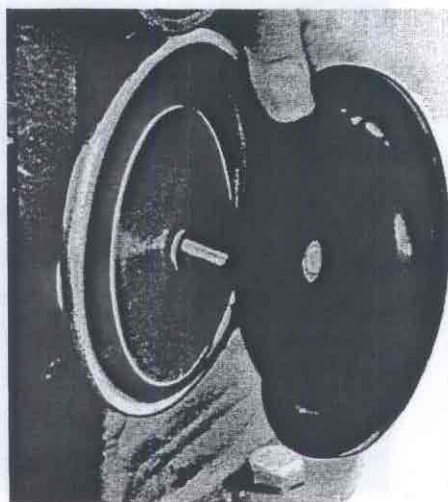

Fig. 43-26. Remove diaphragm

2. Coat the control mechanism contact surface with sealing agent and secure the mechanism to the auxiliary gearbox.
3. Remove the cover on the control cylinder and the spring, see Fig. 43-25.
4. Remove the nut on the pull rod. Remove the diaphragm and the washers, see Fig. 43-26. Take care of the washer in the centre of the diaphragm.
5. Pull the pull rod and check that the flange is in full mesh with the output shaft. Screw in the nut on the pull rod so that it is on the inside of the holed nut. Fit the inner washer for the diaphragm on the rod. Press the washer against the holed nut. When the pull rod is pulled back and forth there should be a clearance of 0.1 mm (0.0039"). If necessary, adjust until the correct clearance is obtained, see Fig. 43-27.
6. Fit the diaphragm and place the spacer washer in the centre of the diaphragm, see Fig. 43-26. Fit the outer washer and lock nut. Hold the diaphragm and washer when tightening up the nut.
7. Fit the thrust spring, see Fig. 43-25, and the cover, see Fig. 43-28. Screw the bolt to the bottom. Screw out the bolt 53/10 turns (8 mm = 5/16"). Tighten up the lock nut.

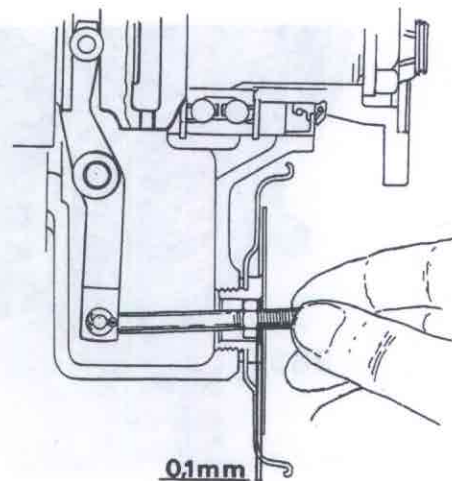
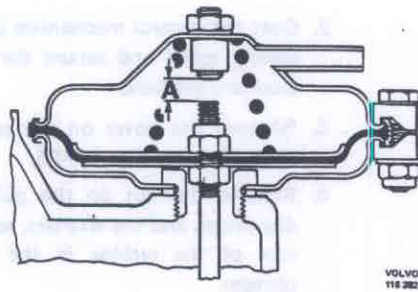

Fig. 43-27. Adjusting clearance



A = 5 3/10 turns (8 mm)

Fig. 43-28. Adjusting screw

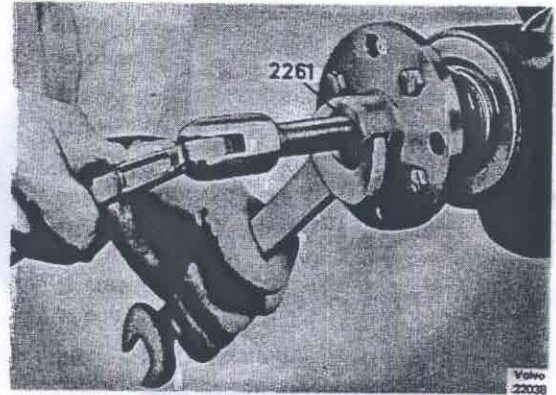

Fig. 43-30. Removing flange

8. Fit the propeller shaft and tighten up the bolts to a torque of 55–65 Nm (5.5–6.5 kpm = 40–47 lbftf).
9. Fit and tighten up the evacuation and vacuum hoses.
10. Place the floor plate in position and screw it tight. Fit the engine casing.

Fill the auxiliary gearbox with oil. Concerning quantity and type, see under "Data".

Replacing flange seal for control mechanism and output shaft

Special tools: 1845, 2261, 2806, 2837, 4030.

1. Remove the propeller shaft from the flange.
2. Fit counterhold 2837, see Fig. 43-29, on the flange (applies only to the control mechanism). Unscrew the nut.
3. Fit not puller 2261, see Fig. 43-30, and pull off the flange.
4. Pull out the seal with 4030, see Fig. 43-31.
5. Fill the space between the sealing lips and their reverse sides with grease, see Fig. 43-32.

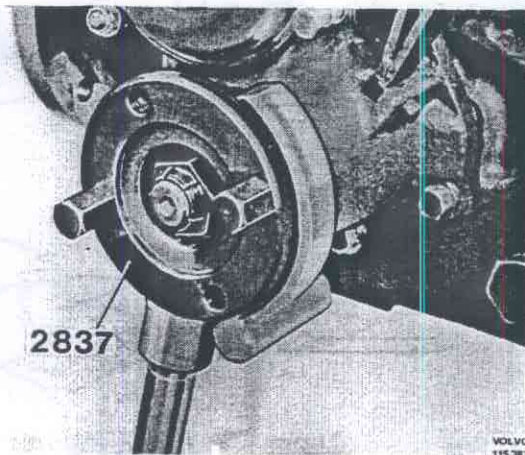

Fig. 43-29. Fitting counterhold

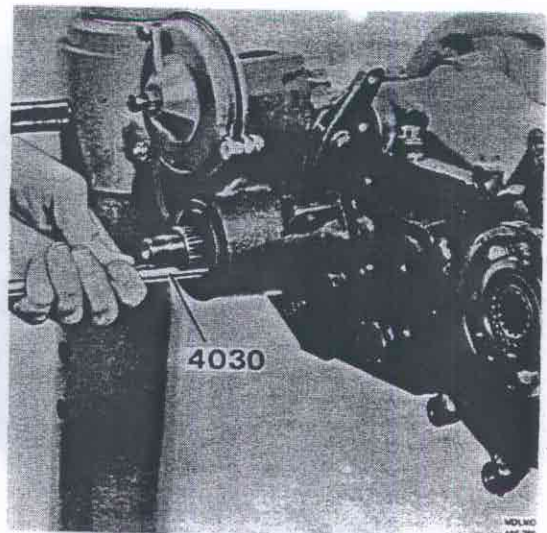

Fig. 43-31. Removing seal

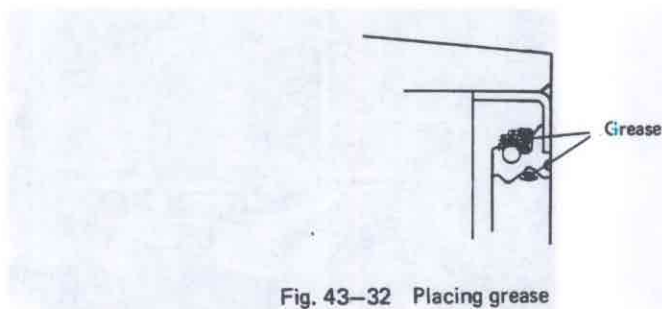

Fig. 43-32 Placing grease

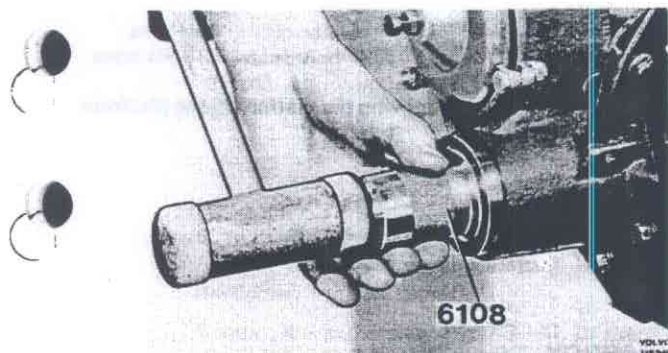

Fig. 43-33. Driving seal

6. Drive the seal into the housing with 2806, see Fig. 43-33.

Fit a new seal on the flange, see Fig. 43-34.

7. Pull on the flange with 1845, see Fig. 43-35. Remove the tool and fit 2837. Fit the nut and tighten it to a torque of 280–300 Nm (28–30 kpm = 202–217 lbftf).

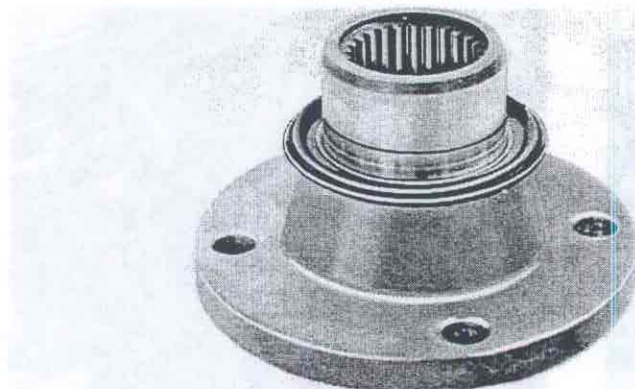

Fig. 43-34. Flange seal

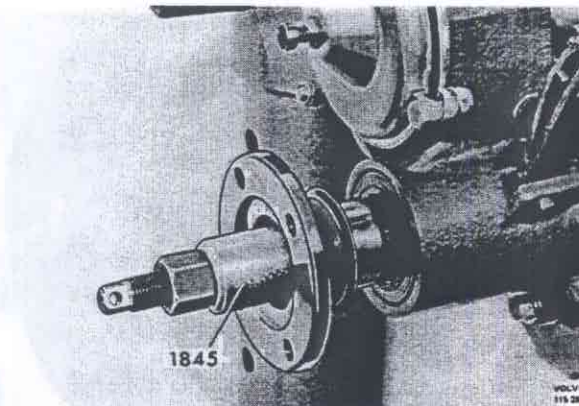

Fig. 43-35. Pressing flange

8. Fit and tighten up the propeller shaft. Tighten the bolts to a torque of 55–65 Nm (5.5–6.5 kpm = 40–47 lbftf).

Replacing the diaphragm in control cylinder

1. Remove the casing over the engine. Remove the bolts securing the floor plate. Remove the plate.
2. Remove the bolts securing the cover. Remove the cover and the spring, see Fig. 43-36.
3. Remove the nut on the pull rod. Hold the thrust washer and diaphragm securely so that they do not twist. Remove the thrust washer and dia-

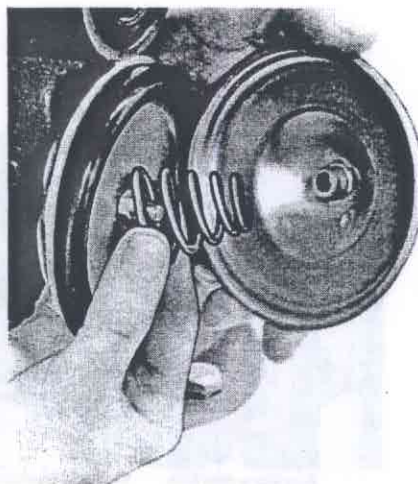

Fig. 43-36. Removign cover